

ខ្ញុំជាកូនរបស់ព្រះ

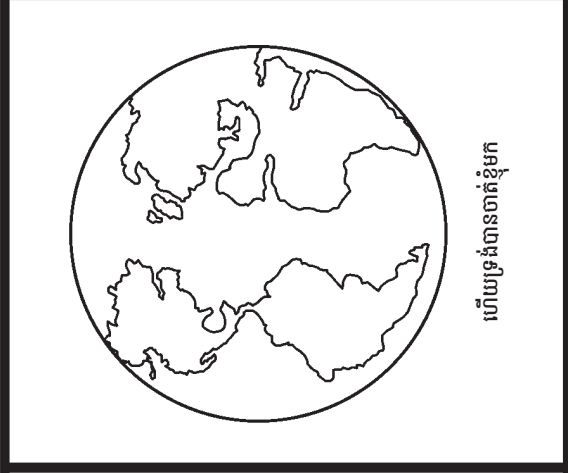

ហើយទ្រង់បានចាត់ខ្ញុំមក

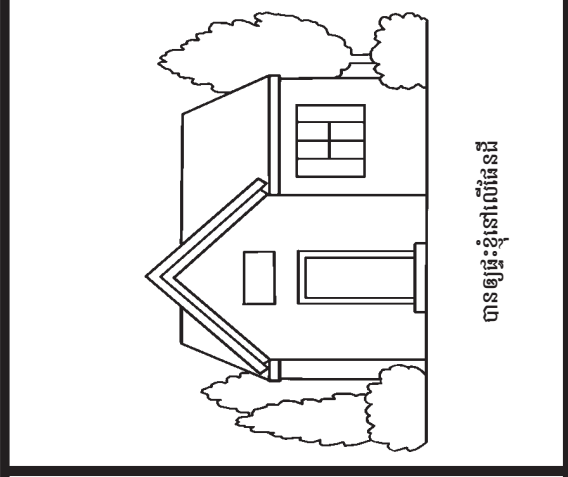

បានឲ្យផ្ទះខ្ញុំនៅលើផែនដី



ជាមួយឪពុកម្តាយល្អ

ខ្ញុំជាកូនរបស់ព្រះ (កិច្ចការ ១៧:២២-៣១) ។

សូមកត់សម្គាល់គុណព្រះវែងទាំងពីរនេះចេញ រួចហើយបិតវាចេញជាបន្តបន្ទាប់គ្នាដើម្បីធ្វើជាបន្ទះវែងមួយ ។
សូមបត់វាទៅមកតាមបន្ទាត់ខ្មៅដិតឲ្យទៅជាអង្កាញ់ៗ ដើម្បីធ្វើជាកូនសៀវភៅតូចមួយ ។

បិតគ្រង់នេះ

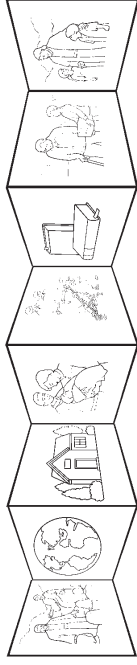

បិតគ្រង់នេះ

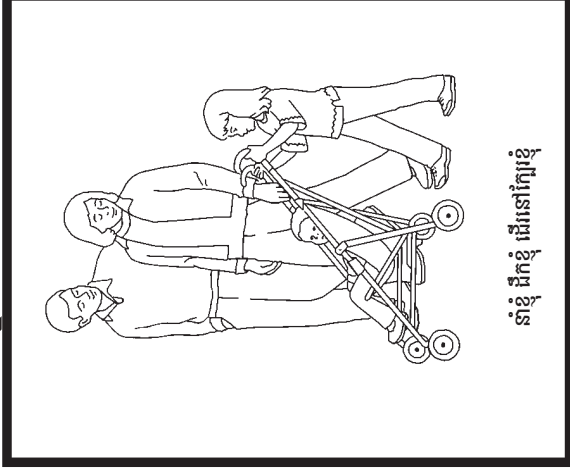

នាំខ្ញុំ ដឹកខ្ញុំ ដើរនៅក្បែរខ្ញុំ

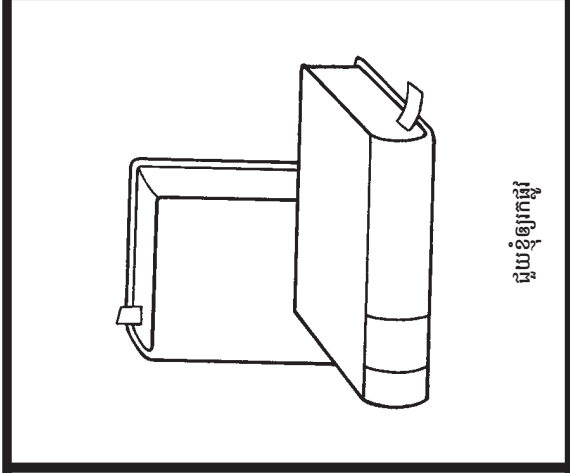

ជួយខ្ញុំឲ្យរកផ្លូវ

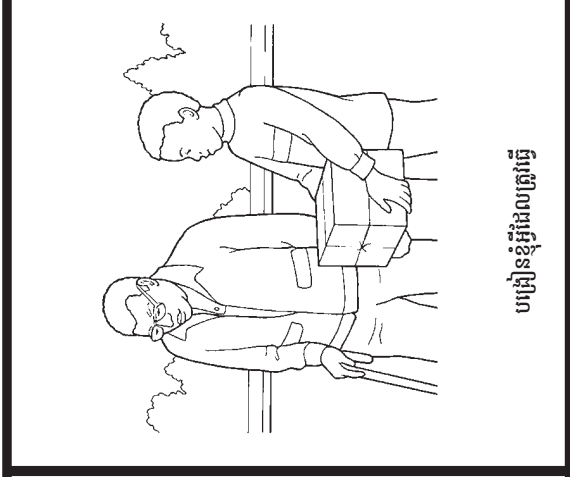

បម្រើនូវខ្ញុំដោយគ្រូបង្វែរ

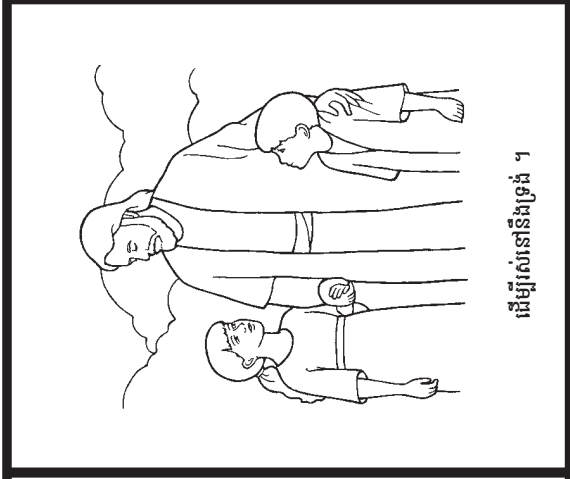

ដើម្បីសរសេរនិងទ្រង់ ។