

Au luve ni Kalou,

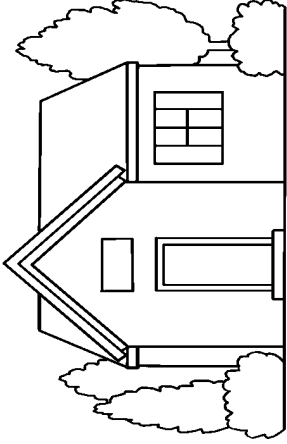

E a talai au mai,



Au susu ka susugi mai

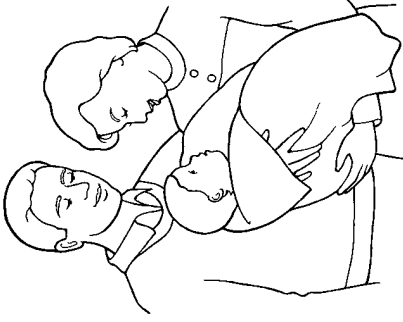

Ka dau karoni tu.

Au Luve ni Kalou (Cakacaka 17:22-31).

Kotiva wawolita na kisi balavu e rua ka vakabira vata me dua kina na tikinipepa balavu. Lobika e muri e liu ena laini loaloa mera veiveivacvani mo bulia kina e dua na ivola lailai.

Tepitaka eke

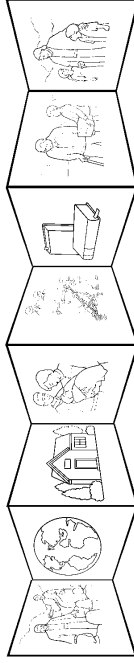

Tepitaka eke

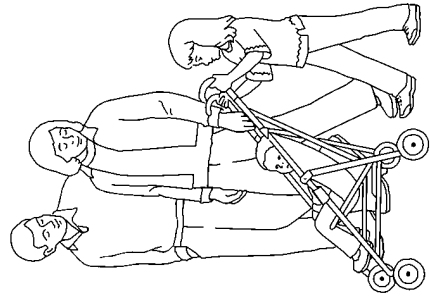
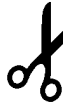

Meu tuberi ka liutaki,

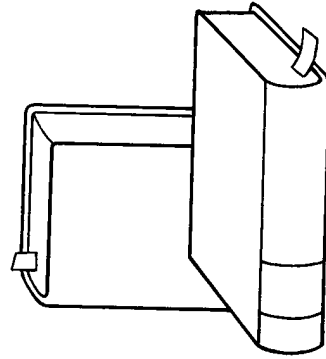

Tiko tikoga.

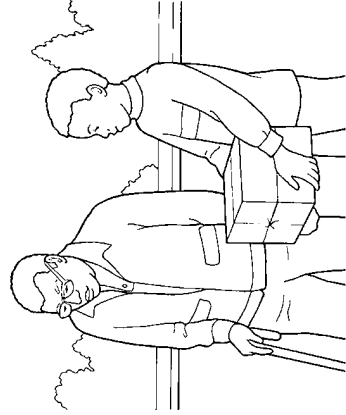

Meu vulica rawa tu.

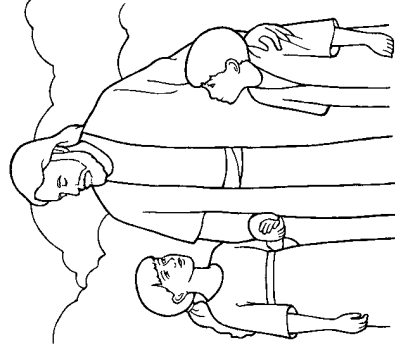

Na bula vou ko ya.