

Ña Nejin Anij,

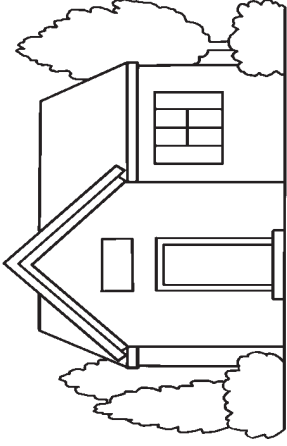

im jilkintok iō ñōn laj,



Letok jikū

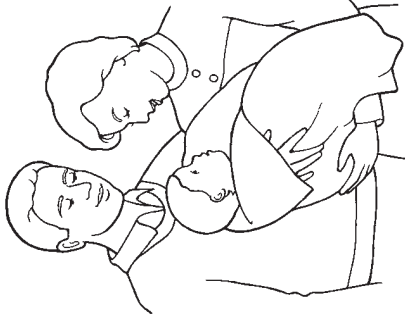

Jinō jemā rejojij im yokwe iō.

### Ña Nejin Anij (Jerbal 17:22-31).

Mwijitjok reektañkōj ko ruo im tepi ippān doon ñan kōmṃane juon to aetoktok. Lim-limi ilo Jain ko rekilmejeej āinwōt juon mōttan ñan kōmṃan juon bok jidikdik.

Tepe ijjin

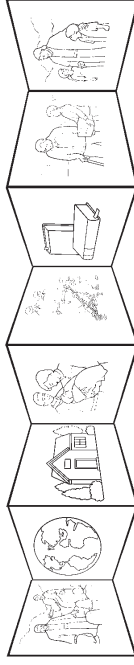

Tepe ijjin

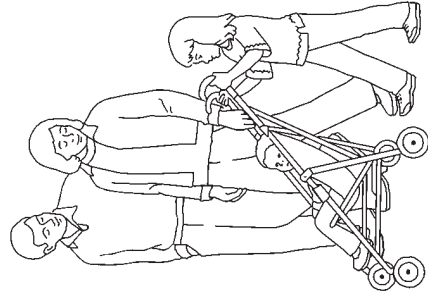

Tel iō, lor iō, etetal ibbā,

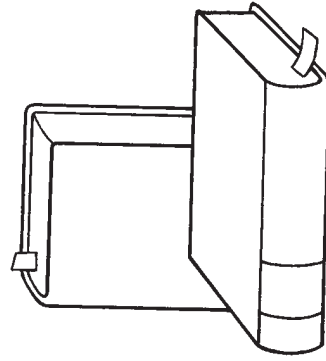

Jibañ iō aolep ien.

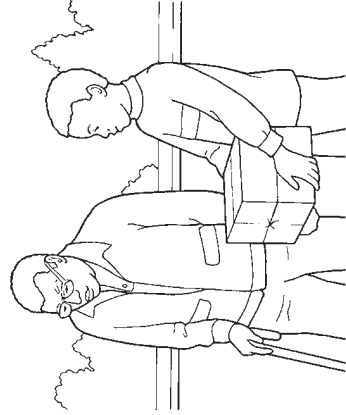

Katakin eō aolep men

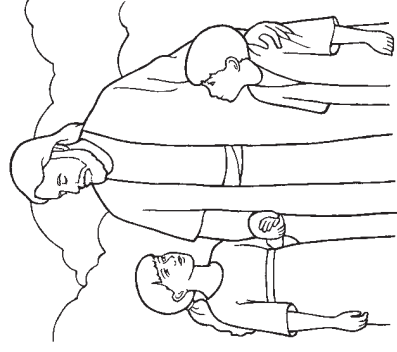

Ko ñan E aolep raan.