

E tamarī'i au

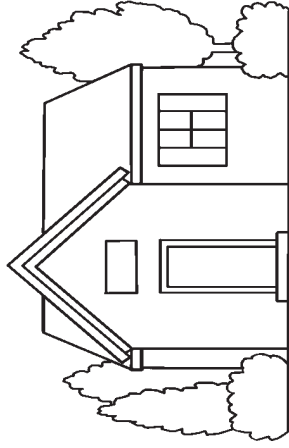

Nā te Atua ra,



Fare 'oa'oa tō'u,

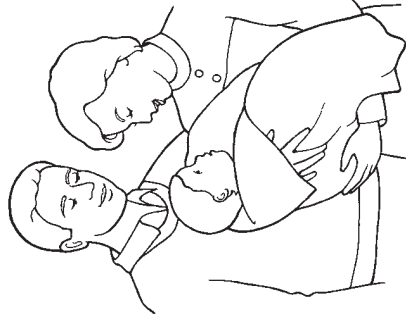

Te metua maita'i.

**E tamarī'i au nā te Atua (Te mau 'Ohipa 17:22-31).**

Tāpūpū i nā 'oehā rorooa e piti 'e tāpiri ia rāua.  
Tūfetu nā mua 'e nā muri nā ni'a i te mau rēni 'ere'ere mai te hō'ē  
'ōteni (accordéon) nō te hāmani i te hō'ē buka iti.

Tāpiri i'ō nei

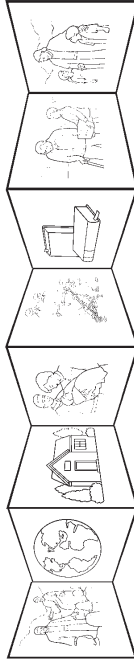

Tāpiri i'ō nei

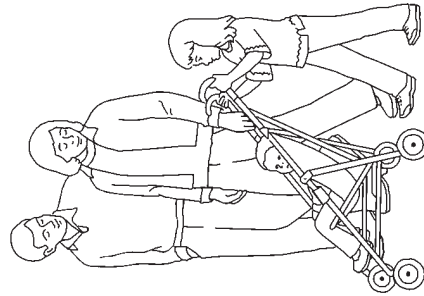

Arata'i mai iā'u

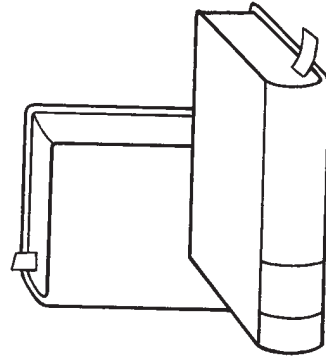

I te 'e'a mau.

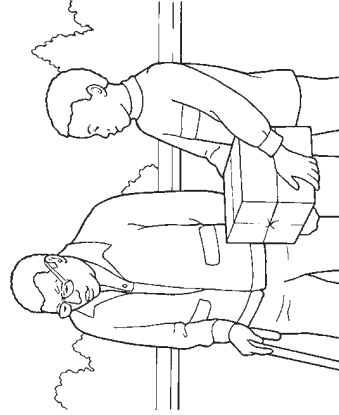

Parau mai te tano iā'u

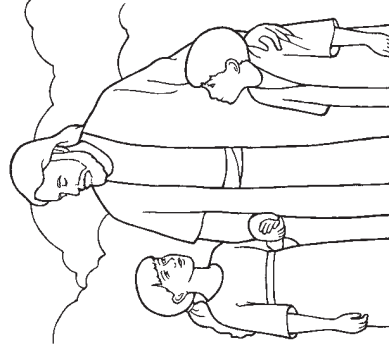

'Ia ora iāna ra.