

Božji sem otrok,

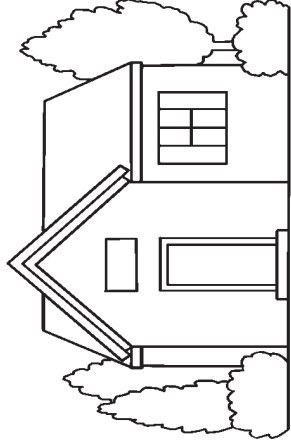

in on me je poslal,



ljubeče starše, varen dom

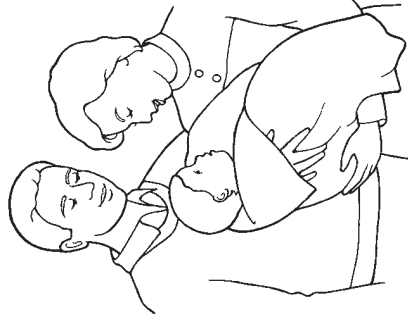

na zemlji mi je dal.

Sem Božji otrok (Apostolska dela 17:22-31).

Izreži dva dolga pravokotnika in ju zlepi skupaj tako, da dobiš dolg trak.
Kot harmoniko ga prepegibaj po črnih črtah, da dobiš knjižico.

Zlepi tukaj.

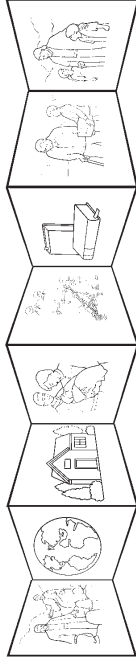

Zlepi tukaj.

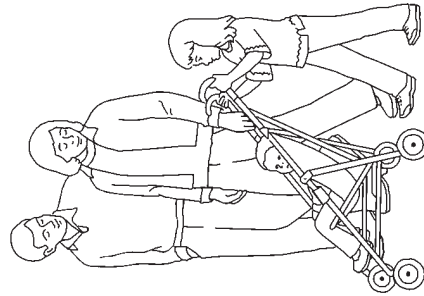

Vodi me in hodi z mano,

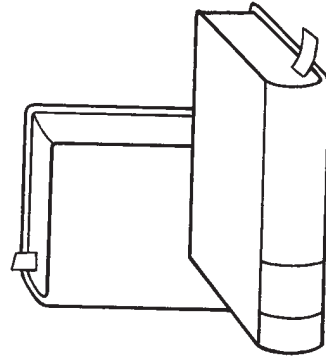

da bom našel pot,

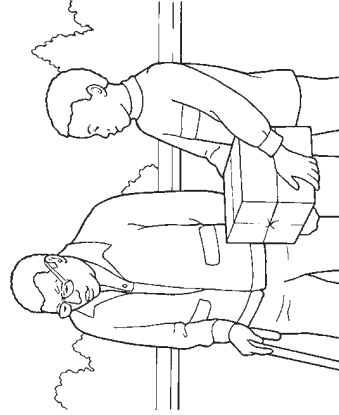

uči me, kaj naj storim,

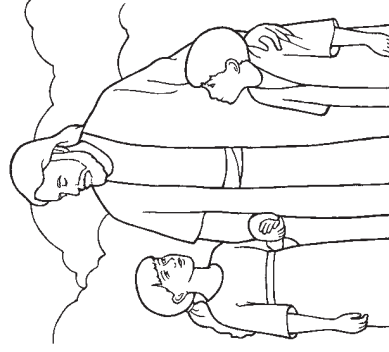

da z mano bo Gospod.