

Fānau au 'a e 'Otua,

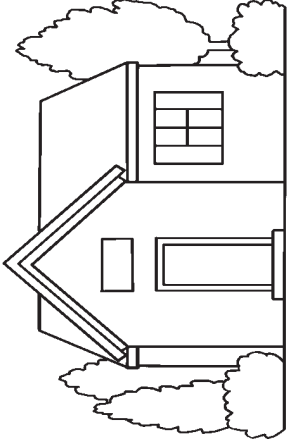

Kuó Ne fekau mai au,



Kuó ne 'omi ha 'api 'i he he māmaní

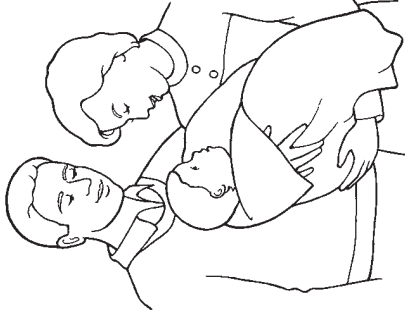

Mo e ongomātu'a 'ofa mo 'ofeina.

Fānau Au 'a e 'Otuá (Ngāue 17:22-31).

Kosi'i 'o to'o e ongo fo'i lekitengikolo lōloá pea fakapipiki fakataha'i kinaua ke fa'u ha fo'i la'ipepa lōloa pē 'e taha. Fepelu'aki 'i he ngaahi laine 'uli'uli 'o hangē ha [ki'i i pelupelú pe me'alea fetohoaki (accordion)] ke fa'u ha ki'i tohi.

Fakapipiki heni

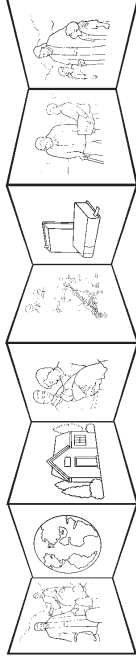

Fakapipiki heni

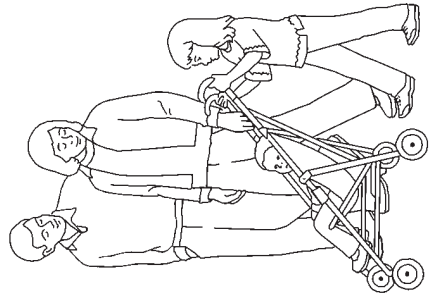

Taki au, 'eva mo au,

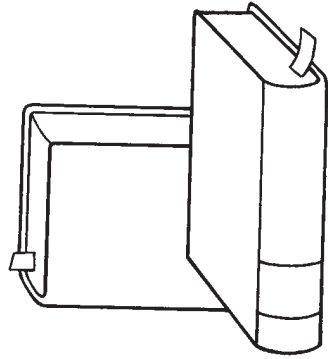

Tokoni'i au ke u 'ilo 'a e halá.

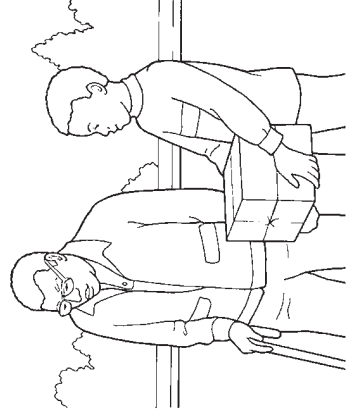

Ako'i au 'i he me'a kotoa 'oku pau ke u fakahokó

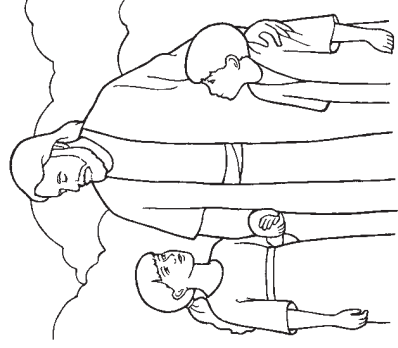

Ke nofo mo la ha 'aho.