

Ako ay anak ng Diyos,

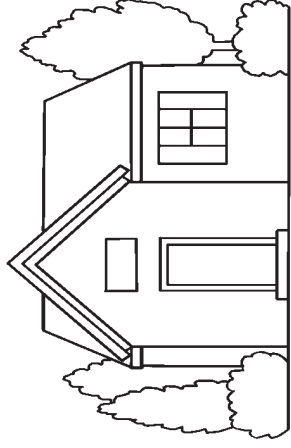

Dito'y isinilang,



Handog sa 'kin ay tahanan't

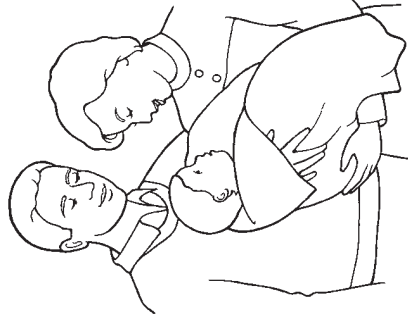

Mabuting magulang.

Ako ay anak ng Diyos (Mga Gawa 17:22-31).

Gupitin ang dalawang mahabang parihaba at i-teyp sa isa't isa ang mga ito para makagawa ng isang mahabang strip.

Itupi nang patalikod at paharap sa itim na mga linya na parang accordion para makagawa ng isang maliit na bukiet.

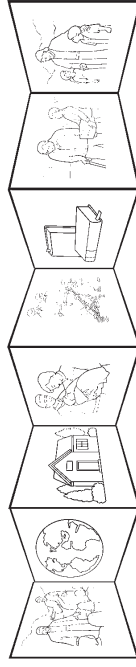

i-teyp dito

i-teyp dito

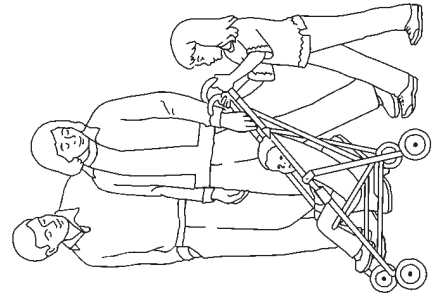

Akayin at patnubayan,

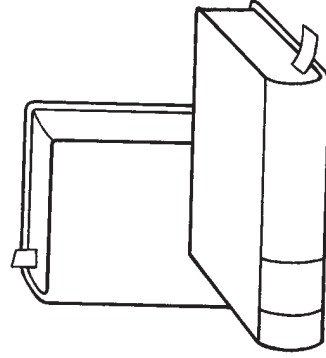

Sa tamang daan,

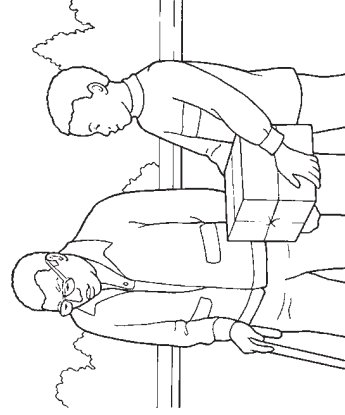

Turuan ng gagawin

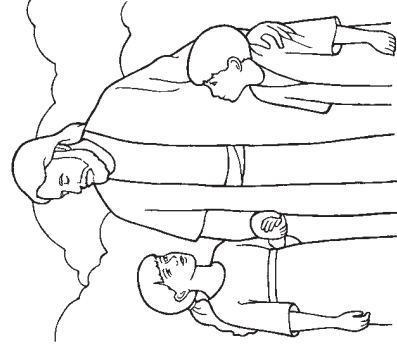

Nang S'ya'y makapiling.