

Zanaky ny Ray Aho,

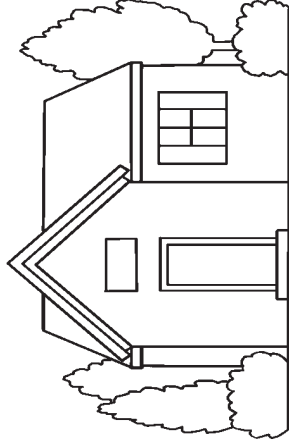

napetrany ety.



Nomeny fianakaviana aho

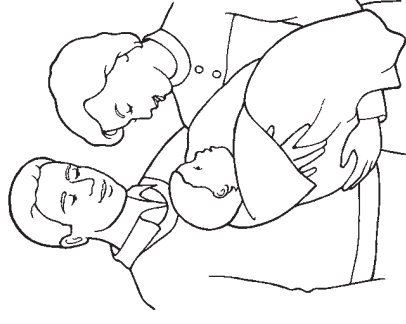

ray aman-dreny tia.

### Zanak' Andriamanitra aho (Asan'ny Apostoly 17:22-31).

Tapaho ireo mahitsizoro lava roa ary apetaho miaraka izany mba hanamboarana taratasy lavabe iray. Aforeto any aoriana avy eo any aloha tahaka ny angorodao eo amin'ireo tsipika mainty mba hanamboarana kiboky iray.

Araiketo eto

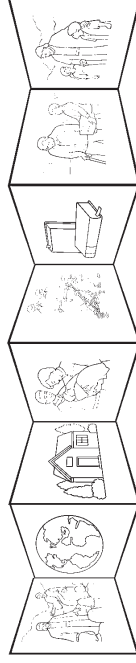

Araiketo eto

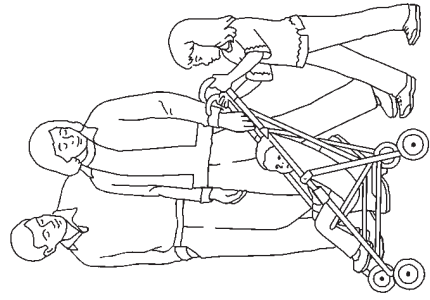

Tantano aho mba hahita ilay

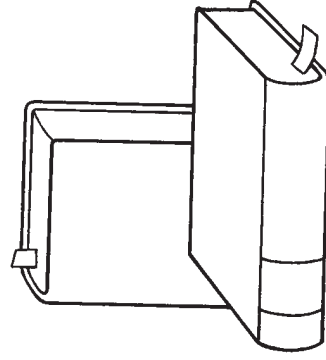

lalana mankany.

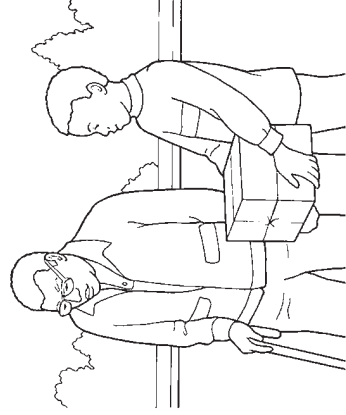

'Zay rehetra ilaina atao.

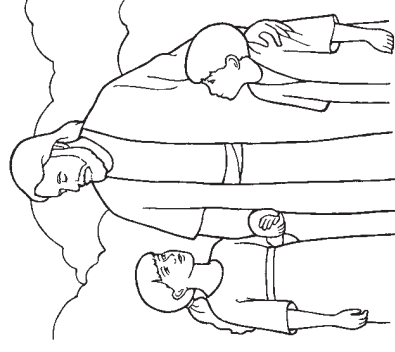

mba ho tafaverina any.