

Jeg er Guds kære barn

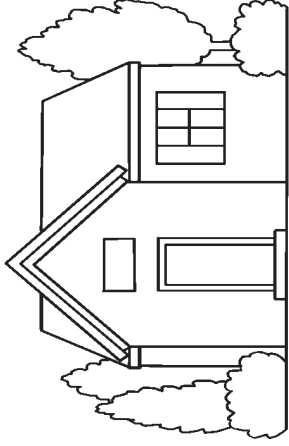

og han har sendt mig her,



har givet mig et jordisk hjem,

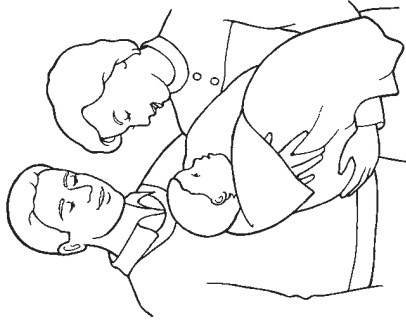

med far og mor så kær.

Jeg er Guds kære barn (ApG 17:22-31).

Klip de to lange rektangler ud og tape dem sammen til en lang strimmel.
Fold dem skiftevis den ene og den anden vej på de sorte streger
som en harmonika, så det bliver et lille hæfte.

Sæt tape her

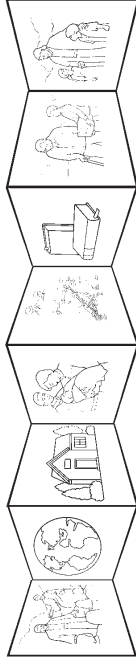

Sæt tape her

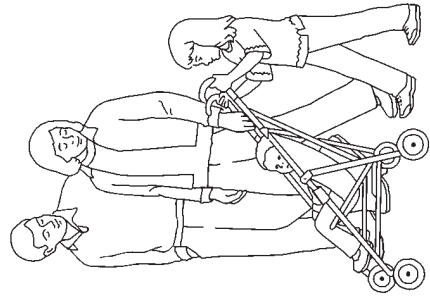

Led mig, før mig, gå du med mig,

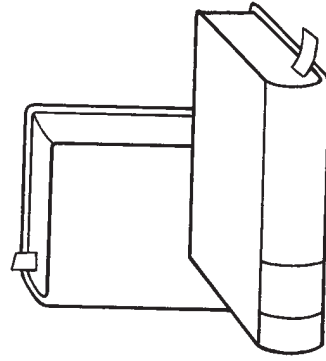

hjælp mig finde vej,

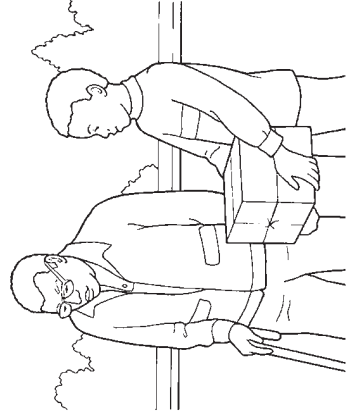

lær mig hvad jeg gøre må,

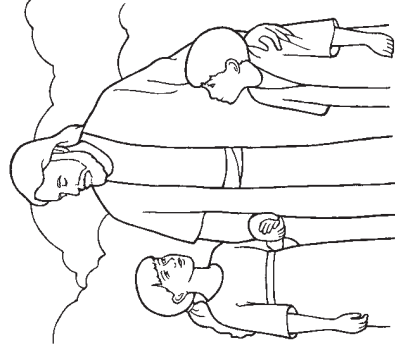

for hjem til Gud at nå.