

Laa'in jun rala*l* li Dios

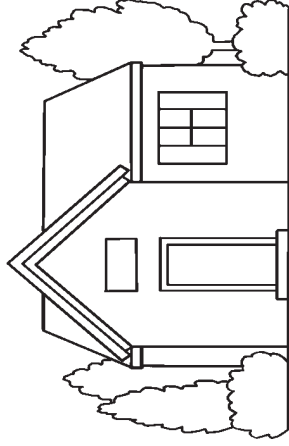

Ut xinixtaqla arin.



Kixk'e lin na' ut lin yuwa',

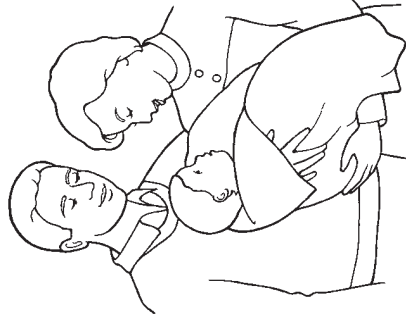

Chaab'il xch'ooleb' wik'in.

Laa'in jun rala*l* li Dios (Hechos 17:22-31).

Seteb' li wiib' chi kaaxukuut li najteb' roq ut latzeb' rik'in cinta re xyiib'ankil jun ajwi' li kaaxukuut najt li roq.

B'as sa'eb' li junjung chi juch' re xyiib'ankil jun ch'ina tasal hu.

Oksi cinta arin

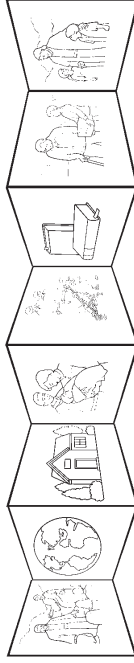

Oksi cinta arin

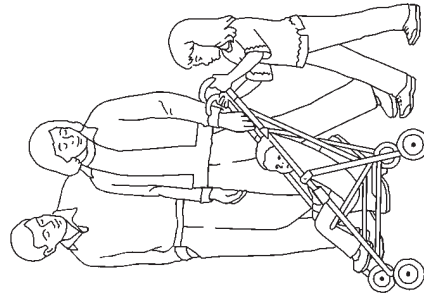

Chinaatenq'a, chinaatzol,

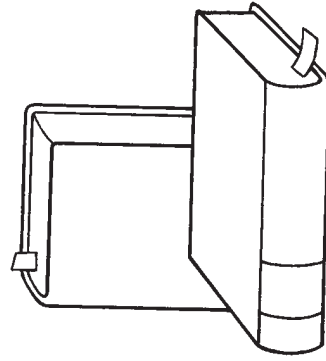

Chatb'eeq laa'tat wik'in.

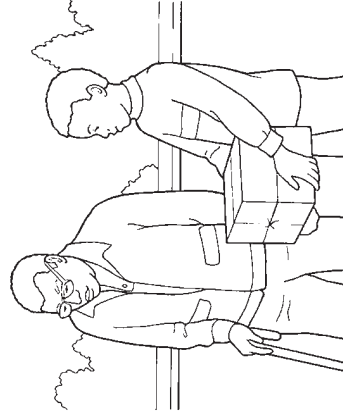

K'ut chiwu li tinb'aanu

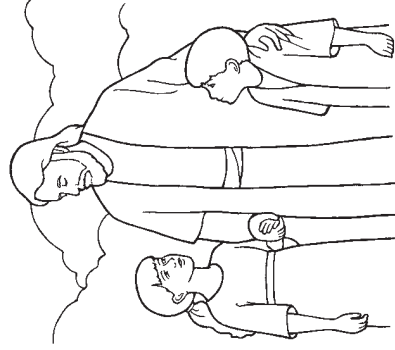

Re tinsutq'iiq rik'in.